

FLANGE SPREADERS

One-Size-Fits-All

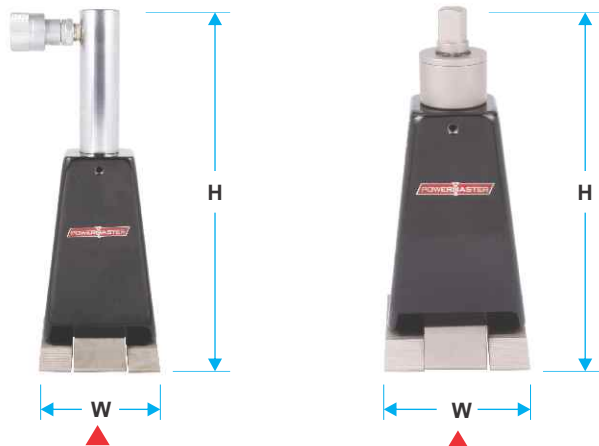

HS10K Hydraulic Model

MS10K Manual Model

Choose Manual or Hydraulic

- Jaws open parallel.
- No drift. It stays where you place it.
- Easy one person operation.
- Universal. One-Size-Fits-All.
- 4535 Kg (10,000 lbs) applied force at tips.

With the Hydraulic Power-Spreader, **HS10K**, a hydraulic cylinder replaces the ratchet handle. A standard hand pump powers 1 Power-Spreader, or a pair, with ease. Again, you are supplied with 4535 kg (10,000 lbs) of force and 76.2 mm (3") of gap; ample for gasket replacement or turning of blinds. Using the manual Power-Spreader, **MS10K**, simply place the tips between the flange faces and turn the ratcheted handle. The ratcheting action is transformed into 4535 Kg (10,000 lbs.) of spreading force and creates up to 76.2 mm (3") of gap.

Model No.	Type	H	W	Access Gap	Stroke	Weight
		mm	mm	mm	inch	kg
HS-10K	Hydraulic	249	116	2.3	3	7.50
MS-10K	Manual	287	116	2.3	3	7.20

HYDRAULIC FLANGE SPREADERS

Hydraulic Flange Spreaders are used for safety opening pipe flanges. Available in capacities of 5 tonnes and 10 tonnes the versatility of both models enables the user to open flanges up to 92mm thick. Operated with a standard hydraulic hand pump and connecting hose and supplied in a handy steel storage case, Hydraulic Flange Spreaders can be operated individually, or as a pair when opening large diameter flanges. With Hydraulic Flange Spreaders it takes minutes open the toughest flanges without the risks of sparks caused by hammer blows and chisels.

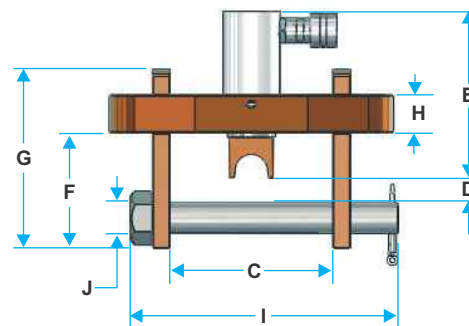
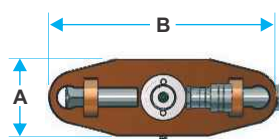

(All Dimensions in MM)

Model No.	A	B	C		D	E	F	G	H	I	J
			min	max							
FS-50	77	210	61	157	10	192	69	131	25	205	18
FS-100	110	290	61	226	30	165	89	180	38	274	31

Model No.	Capacity	Stroke	Oil Capacity	Max. Flange Thickness	Flange Diameter	Stud Size	Standard Wedge	Optional Wedge
	tonnes	mm	cm ³	mm	mm(inch)	mm	mm	mm
FS-50	5	39	25	2 x 58	1150mm(45")	19 - 29	3 - 29	30 - 56
FS-100	10	55	78	2 x 93	1900mm(75")	32 - 41	3 - 29	30 - 56

HYDRAULIC VERTICAL LIFTING WEDGE HVW-10



The HVW-10 has been developed as an easy to use / cost effective way to find solutions to heavy lifting where minimal clearance is available. It will lift objects vertically where an access gap of 3/8”(9.5mm) or more is available. The HVW-10 will lift an object fast, secure and safe with a lifting force of 16 Tons per tool. Multiple units can be used if greater lifting force is needed.

The Most Practical/Safe Option :

The HVW-10 can be used for :	
<ul style="list-style-type: none"> • Lifting Heavy Machinery • Equipment Installation • Plant Maintenance 	<ul style="list-style-type: none"> • Equipment Alignment • Assisting with Toe Jack Access

Special Features :

- Access gap of only 3/8”(9.5mm) needed.
- 3/4”(19.0mm) of vertical lift available from each step.
- Max. height of 50mm on 4th step.
- Automatic spring return retraction.
- Interlocking first step ensures safe hold.
- No Slippage due to locking.
- Will lift in a straight vertical place.

Operating Benefits :

- Time / Cost Savings.
- Lowest Weight / Lifting Force Ratio.
- Precise.
- Easy to set up and use.
- Safe.
- Minimal Maintenance.
- Fast for labour & time savings.
- Use multiple units for greater lifting.

Kit Options :

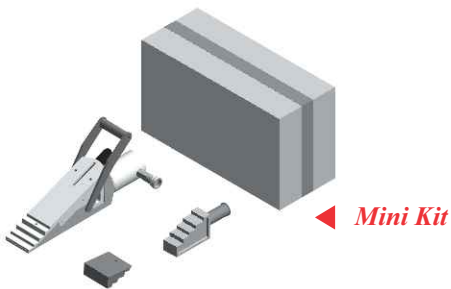

- 1 x Hydraulic Vertical Lifting Wedge Assembly
- 1 x Safety Block
- 1 x Stepped Block
- 1 x Instruction Manual
- 1 x Carry Case

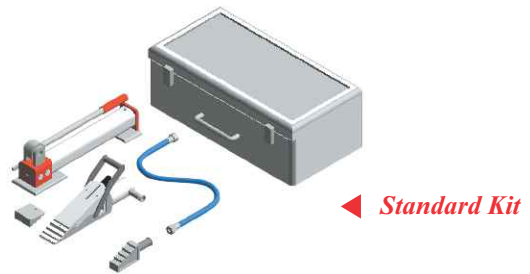

- 1 x Hydraulic Vertical Lifting Wedge Assembly
- 1 x 10,000 psi (700 Bar) Two Stage Hydraulic Hand Pump
- 1 x 10,000 psi (700 Bar) Hydraulic Hose Length 6 feet
- 1 x Safety Block
- 1 x Stepped Block
- 1 x Instruction Manual
- 1 x Carry Case

HYDRAULIC SPREADING WEDGE HSW-10



The Spreading Wedge has been developed as the simple cost-effective solution for flange spreading.

The Practical Solution :

The HSW-10 can be used during :

- | | |
|--|---|
| <ul style="list-style-type: none"> • Commissioning • Construction • Routine Maintenance | <ul style="list-style-type: none"> • Shutdowns / Outages • Testing • Valve Change-outs |
|--|---|

Special Features :

- Only requires an access gap of 1/4"(6 mm).
- Robust Light weight Tool-Just 7.2 kg(16 lbs).
- 10,000 psi (700 Bar) generates 14.0 Tons spreading force.
- Automatic Spring Return.
- Locking at first step ensures no slippage increased safety.

Operating Benefits :

- Time / Cost Savings.
- Lowest Weight / Lifting Force Ratio.
- Precise.
- Easy to set up and use.
- Safe.
- Minimal Maintenance.
- Fast for labour & time savings.
- Use multiple units for greater lifting.

Kit Options :

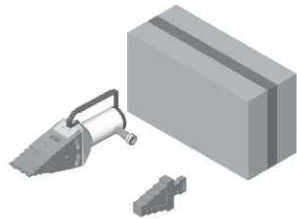

◀ Mini Kit

- 1 x Hydraulic Spreading Wedge Assembly
- 1 x Safety Block
- 1 x Instruction Manual
- 1 x Carry Case
- Gross Weight: 8 kg

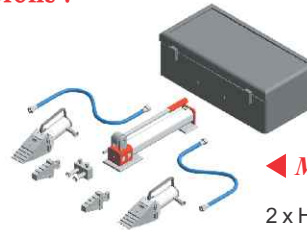

◀ Maxi Kit

- 2 x Hydraulic Spreading Wedge Assembly
- 1 x 10,000 psi (700 Bar)- Two Stage Hydraulic Hand Pump
- 2 x 10,000 psi (700 Bar) Hydraulic Hoses
- 2 x Safety Block
- 1 x Instruction Manual
- 1 x Carry Case
- 1 x 10,000 psi Twin Valve manifold
- Gross Weight: 28 kg



◀ Standard Kit

- 1 x Hydraulic Spreading Wedge Assembly
- 1 x 10,000 psi (700 Bar) Two Stage Hydraulic Hand Pump
- 1 x 10,000 psi (700 Bar) Hydraulic Hoses
- 1 x Safety Block
- 1 x Instruction Manual
- 1 x Carry Case
- Gross Weight: 17 kg

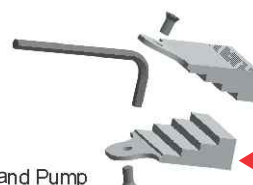

◀ Stepped Block Accessory

- 2 x Stepped Blocks
- 2 x CSK M6 x 12mm Countersunk Screws
- 1 x M4 Allen Key

Sold as a separate item in pairs

MANUAL RATCHETING SPREADING WEDGE MSW-10



The Spreading Wedge has been developed as the simple cost-effective solution for flange spreading. Robust Light weight Tool-Just 6.5 kg (14.3 lbs). Operated mechanically with reversible ratchet of 3/4".

The Practical Solution :

The MSW-10 can be used during :	
<ul style="list-style-type: none"> • Commissioning • Construction • Routine Maintenance 	<ul style="list-style-type: none"> • Shutdowns / Outages • Testing • Valve Change-outs

Special Features :

- Only requires an access gap of 1/4"(6 mm).
- Robust Light weight Tool-Just 6.5 kg(14.3 lbs).
- Operated mechanically with reversible ratchet of 3/4".
- Locking at first step ensures no slippage increased safety.

Operating Benefits :

- Time / Cost Savings.
- Lowest Weight / Lifting Force Ratio.
- Precise.
- Easy to set up and use.
- Safe.
- Minimal Maintenance.
- Fast for labour and time savings.

Kit Options :



◀ Mini Kit

- 1 x Manual Spreading Wedge Assembly
- 1 x Safety Block
- 1 x Instruction Manual
- 1 x Carry Case



◀ Standard Kit

- 1 x Manual Spreading Wedge Assembly
- 1 x Manual Ratcheting Wrench
- 1 x Safety Block
- 1 x Instruction Manual
- 1 x Carry Case
- Gross Weight: 11 kg



◀ Stepped Block Accessory

- 2 x Stepped Blocks
- 2 x CSK M6 x 12mm Countersunk Screws
- 1 x M4 Allen Key

Sold as a separate item in pairs